

C1100 Pro

Parts list

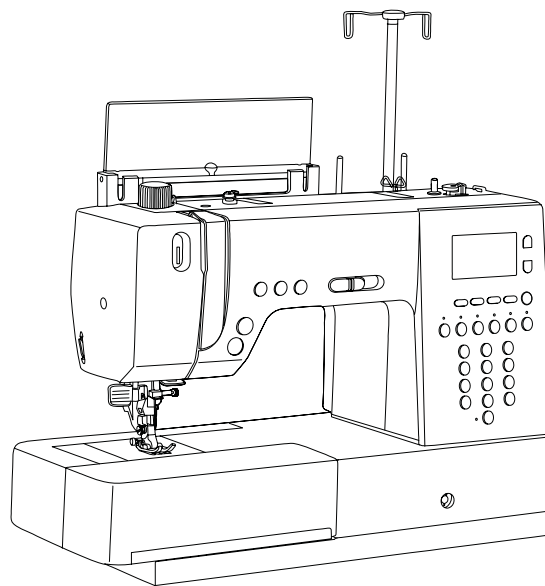

A

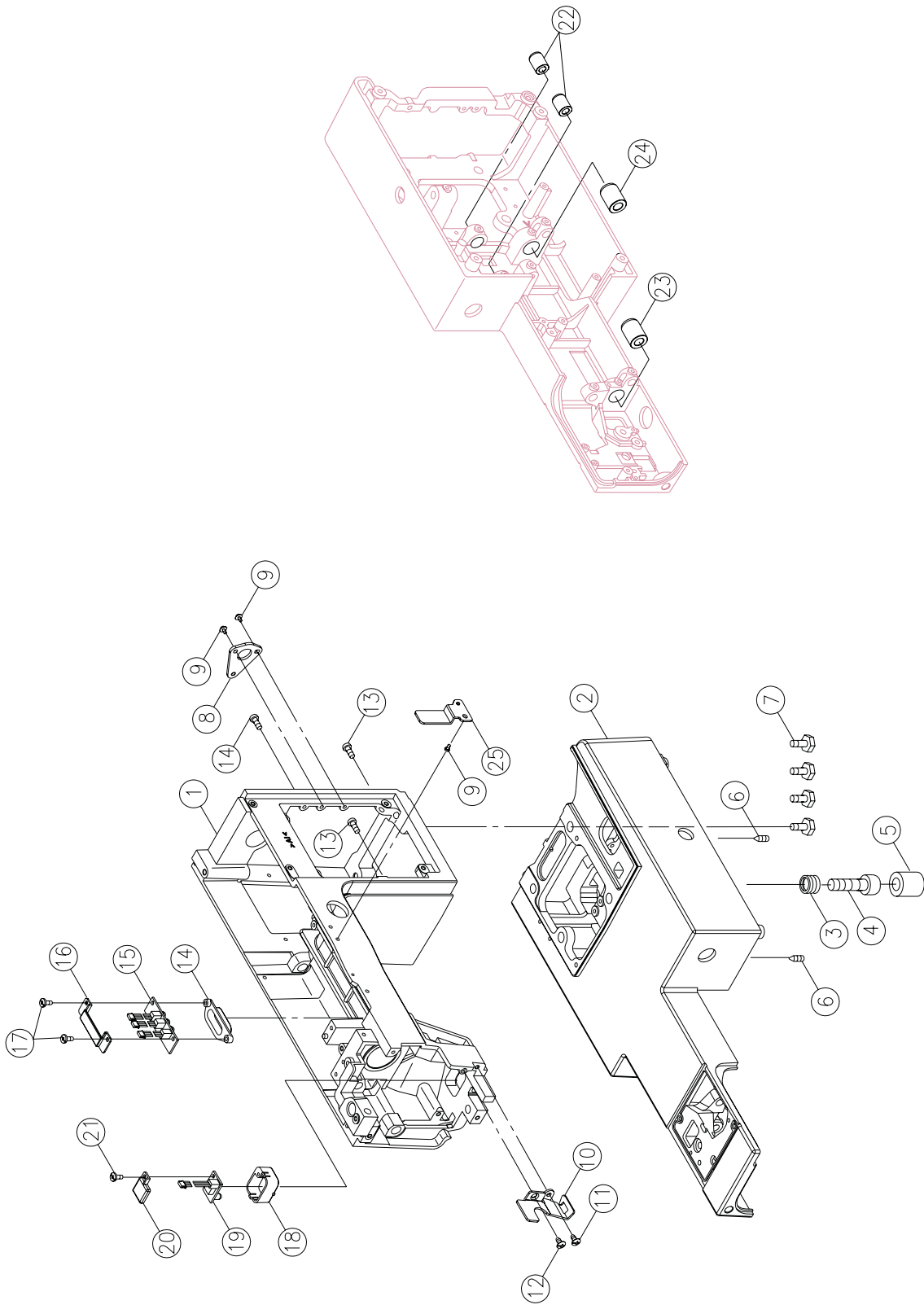

No.	Part No.	Description
1	N/A	Machine upper casting
2	N/A	Free arm base casting
3	270 K82073003	Machine base adjusting screw spring
4	270 K82133006	Machine base adjusting screw
5	270 H70043000	Machine base rubber feet
6	N/A	Pin
7	N/A	Sew screw (M8)
8	N/A	Thread guide plate
9	416121201	Sew screw (M4*6B)
10	N/A	Arm Thread guide plate
11	416121501	Set screw (M4×8 A)
12	270 004240176	Set screw (M4×6 D)
13	N/A	Set screw (M4×8A)
14	416403201	LED cover (B)
15	416403101	LED light sewing area complete (center)
16	N/A	LED cover (3)
17	N/A	Set screw (M3×10A)
18	416403301	LED cover (A)
19	416403401	LED lights head section complete (2)
20	N/A	LED cover (2)
21	N/A	Set screw (M3×8)
22	270 R11443000	Feed regulating bushing
23	N/A	Lower shaft bushing
24	N/A	Lower shaft bushing
25	N/A	Arm front cover set plate

B

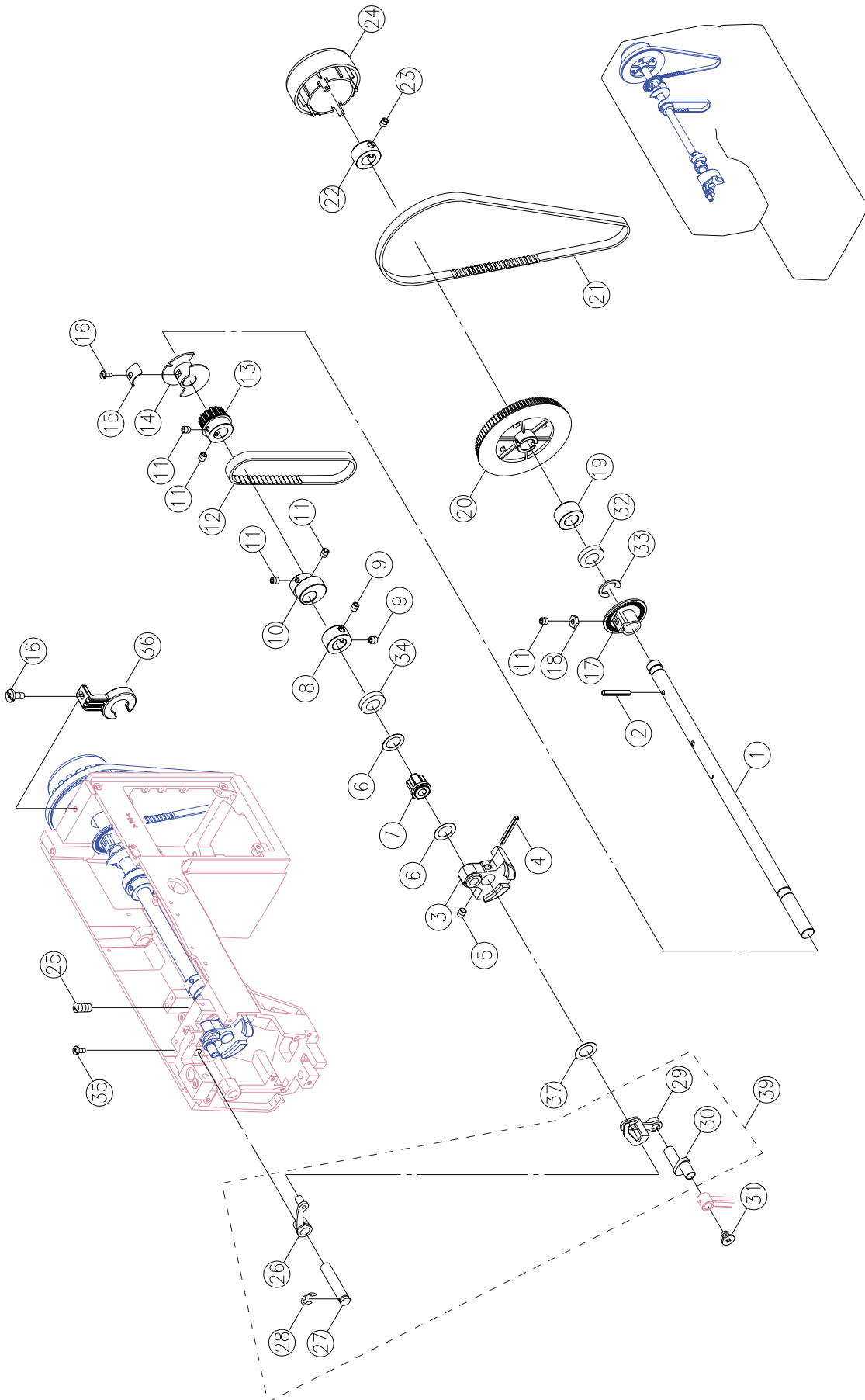

No.	Part No.	Description
1	N/A	Arm shaft
2	N/A	Spring pin (ϕ 3×20)
3	N/A	Arm shaft balance
4	N/A	Arm shaft balance pin
5	N/A	Set screw (M6×6)
6	N/A	Endure attrition washer (13*20*.025)
7	N/A	Arm shaft bushing
8	N/A	Arm shaft collar
9	N/A	Set screw (M6×5)
10	N/A	Shank cam
11	416121001	Set screw (M4×5C)
12	416140501	Motor drive belt
13	416403501	Arm shaft sprocket
14	416403601	Rotary sensor collar
15	270 D3A0043002	Arc washer
16	416121501	Set screw (M4×8A)
17	416403701	Rotary sensor collar
18	270 004840022	Nut (M4 t=3)
19	N/A	Arm shaft bushing
20	416403801	Arm shaft sprocket
21	416403901	Motor drive belt(2M)
22	N/A	Arm shaft collar
23	N/A	Set screw (M4*4C)
24	416404001	Hand wheel
25	N/A	Set screw (M6*14C)
26	416476101	Thread take up lever supporter
27	416476101	Thread take up lever supporter shaft
28	270 003010063	E-Ring (E-6)
29	416476101	Thread take lever
30	416476101	Arm shaft balance pin
31	416404501	left-hand threaded screw (9/64*40*5)
32	416404601	Felt seal (ϕ 12.7 * ϕ 18.7 * t 3.5)
33	416404701	C-Ring
34	N/A	Felt seal (ϕ 19 * ϕ 28 * t 3.5)
35	270 004240066	Set screw (M4*8B)
36	416404801	Felt seal
37	270 0044000020	Washer (6.2*12*.025)
38		
39	416476101	Thread take up complete

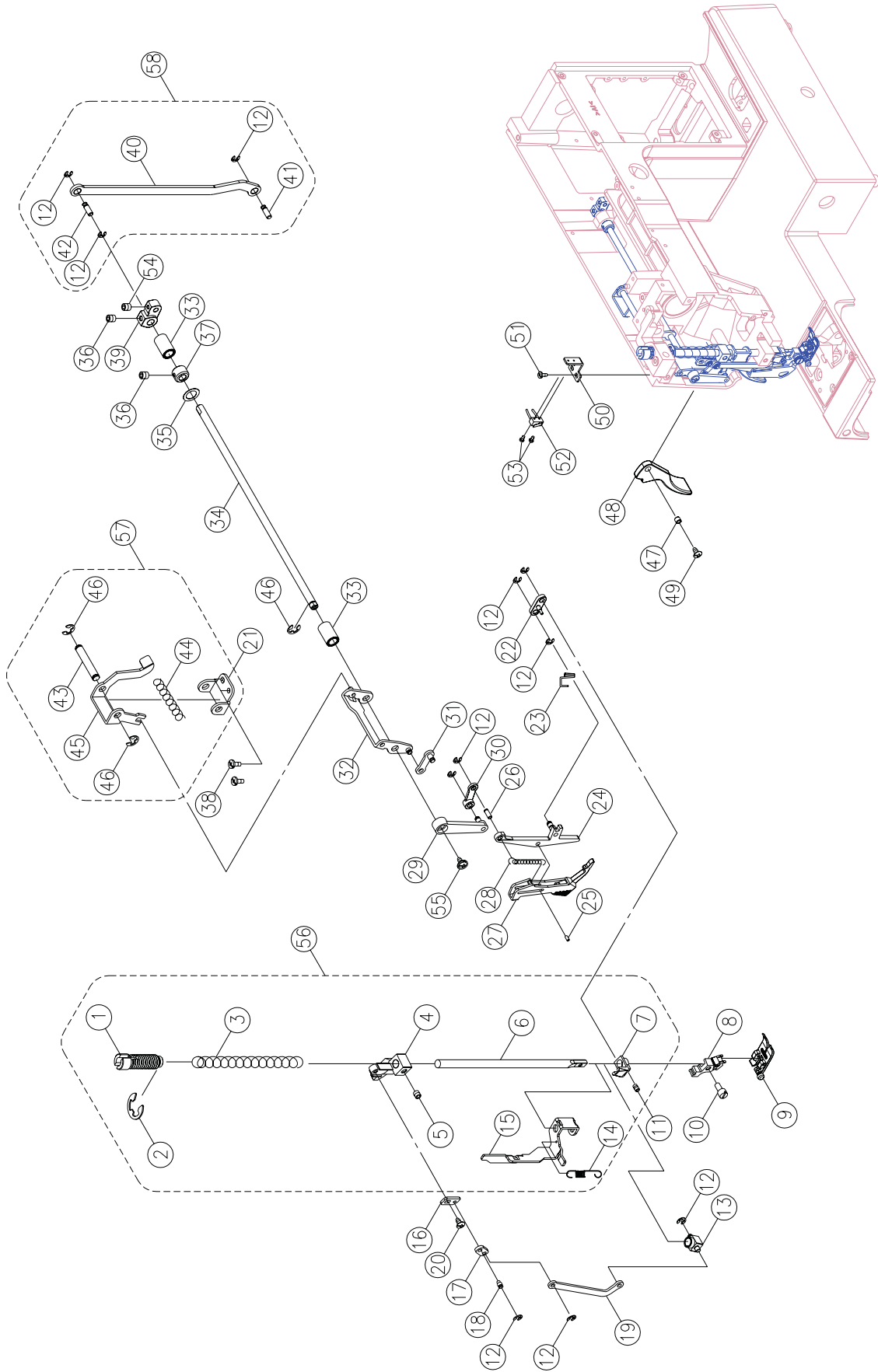

No.	Part No.	Description
1	N/A	Presser bar set screw
2	270 003010093	E-Ring (E-9)
3	416405001	Presser bar spring
4	416405101	Presser bar bracket
5	270 004250203	Set screw (M5×5 C)
6	416430401	Presser bar (PFAFF)
7	416405301	Presser bar ring
8	416430501	PRESSERFOOT SHANK
9	820773096	Standard presser foot (0A)
10	416430601	Set screw (9/64*40*7.5) (PFAFF)
11	416405301	Set screw (M3*6)
12	416116001	E-Ring (E-3)
13	416405801	Presser bar lifter spacer
14	416405901	Movement waft plate bracket spring
15	N/A	Movement waft plate bracket
16	416406001	Feed lever
17	416406101	Feed rod crank
18	416406001	Feed lever pin
19	416406301	Feed rod
20	416121201	Set screw (M4*6B)
21	N/A	Feed supporter
22	416406401	Shank lever
23	416406501	Spring
24	416406601	Shank of deliver cloth foot
25	N/A	Pin
26	N/A	Pin
27	416406901	Dual feed shank
28	416407001	Shank spring
29	416407101	Feed crank
30	416407201	Feed rod
31	416407301	Feed lever
32	416407401	Feed crank
33	N/A	Feed rock bushing
34	416407501	Feed shaft
35	416125901	Washer (6.2*9.6*0.5)
36	270 004240503	Set screw (M4×4C)
37	N/A	Feed collar
38	416121501	Set screw(M4×8A)
39	416407601	Feed crank
40	N/A	Feed rod
41	N/A	Pin
42	N/A	Pin
43	N/A	Feed shaft
44	416407701	Spring
45	N/A	Feed crank
46	416116301	E-Ring (E-5)
47	416407801	Presser bar lifter lever spacer
48	416407901	Presser bar lifter lever
49	416121101	Set screw (M4*10B)
50	N/A	Plate
51	416119201	Set screw (M3×6C)
52	416408001	Presser bar lever micro switch
53	416119101	Set screw (M2*7.5)
54	416120001	Set screw (M3×3C)
55	416408101	Set screw (M3*6B)
56	416430701	Presser bar complete (PFAFF)
57	416408301	Feed shaft complete
58	416408401	Feed rod complete

D

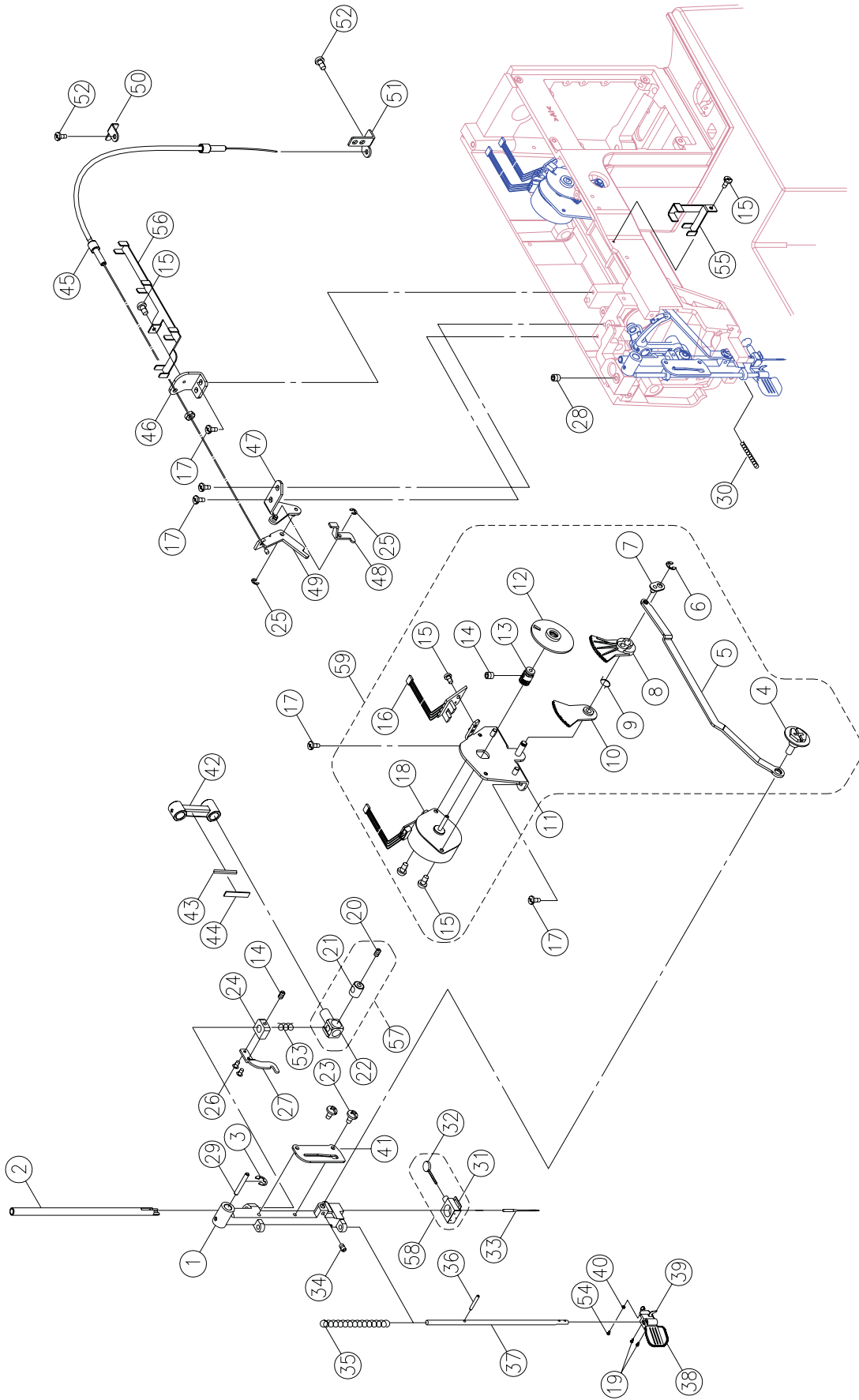

No.	Part No.	Description
1	416408501	Needle bar cradle
2	416408601	Needle bar
3	416116301	E-Ring (E-5)
4	416408701	Needle bar driving rod pin
5	N/A	Needle bar driving rod
6	416116101	E-Ring (E-4)
7	N/A	Needle bar driving rod plate
8	N/A	Zigzag crank (2)
9	416133901	Zigzag crank spring
10	N/A	Zigzag crank (1)
11	N/A	Zigzag pulse motor plate
12	N/A	Pulse motor gear spacer
13	N/A	Pulse motor gear
14	416120001	Set screw □M3×3C □
15	416120601	Set screw □M3×5 A □
16	416411401	Zigzag photo sensor
17	416121501	Set screw □M4×8A □
18	416411401	Pulse motor complete
19	416408801	Set screw (M2*4)
20	270 004240503	Set screw □M4×4C □
21	N/A	Needle bar bracket (2)
22	N/A	Needle bar bracket (1)
23	270 004230076	Set screw M3×5A □
24	416409001	Threading stopper
25	416116001	E-Ring (E-3)
26	270 004220203	Set swcrew □M2×4 □
27	416408901	Threading stop holder
28	N/A	Set screw □M4×6 C □
29	416409101	Needle bar supporter pin
30	416409201	Needle bar supporter spring
31	416411301	Needle clamp
32	416411301	Needle clamp set screw
33	620071196	Univ. needle 70/80/90, 5-p
34	270 004106233	Set screw (9/64*40*5)
35	416409301	Auto threading spring
36	416409401	Spring pin(φ2*16)
37	416409501	Auto threading shaft
38	416409601	Threading plate
39	416409701	Needle threading hook complete
40	416409801	Nut (M2) t=1.6
41	416409901	Auto threading guide
42	416410001	Needle bar crank rod
43	416410101	Oil cotton
44	416410201	Oil cotton holder plate
45	416410301	Brake cord
46	416410401	Brake cord fixed plate
47	416410501	Function fixed bracket complete
48	416410601	Thread function plate
49	416410701	Function pull rod
50	416410801	Brake cord press plate
51	416410901	Lower brake cord plate
52	416121201	Set screw □M4*6 B □
53	416411001	Adjusting plate spring
54	416411101	Set screw □M2×3.5 □
55	N/A	Arm thread fixed bracket B
56	N/A	Arm thread fixed bracket A
57	416411201	Needle bar connecting rod
58	416411301	Needle clamp complete set
59	416411401	Zigzag pulse motor complete

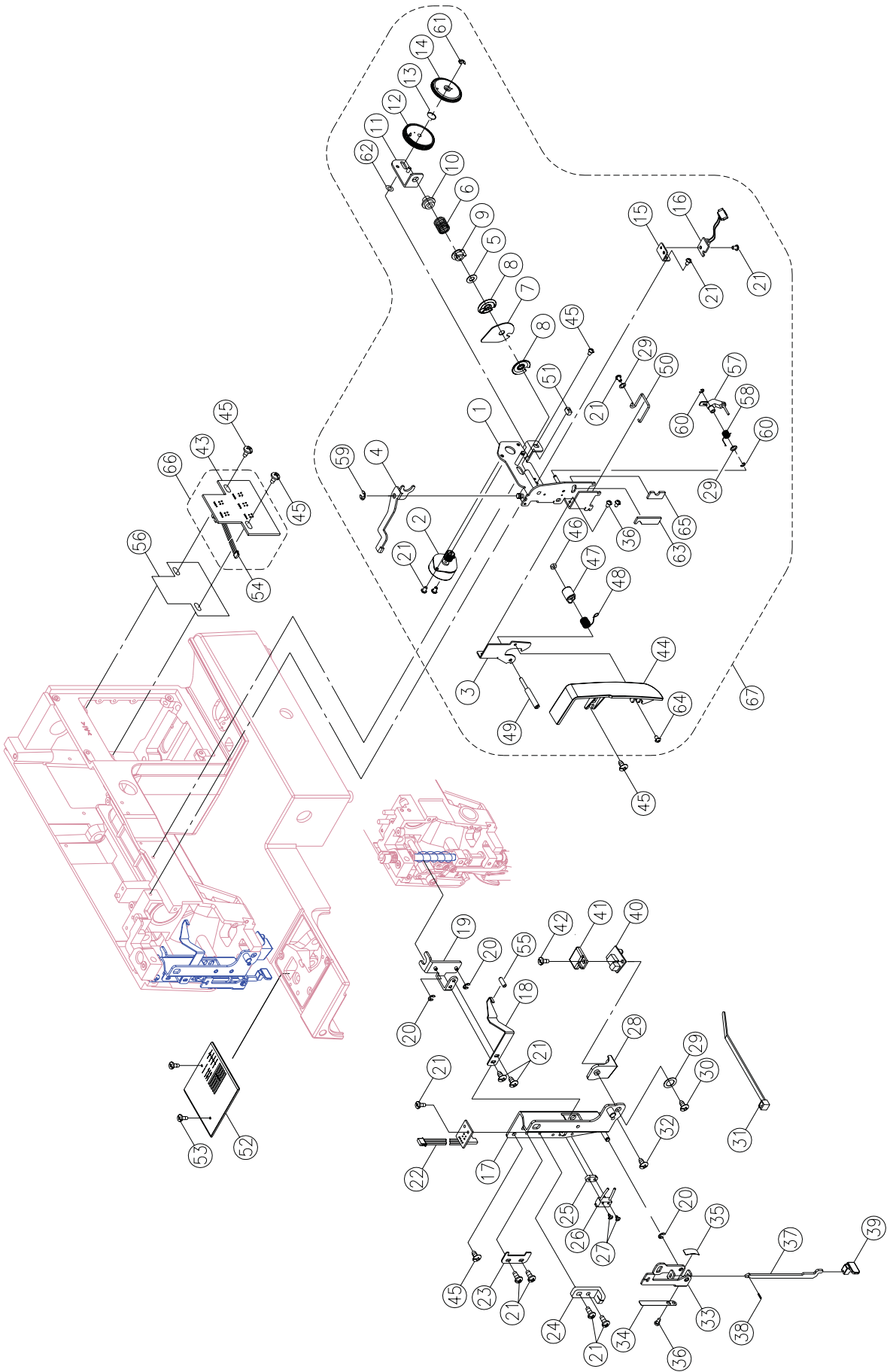

No.	Part No.	Description
1	N/A	Dial tension supporter plate
2	416411501	Dial tension adjusting stepping motor
3	N/A	Thread guide plate
4	N/A	Dial tension waft plate
5	N/A	Washer(□5.5*□11*0.5)
6	416411701	Thread guide spring
7	416411801	Dual thread guide plate
8	416411901	Dial tension plate (B)
9	416412001	Dial tension spring regulator
10	416412101	Dial tension regulator
11	N/A	Dial tension spring plate complete
12	N/A	Dial tension gear B
13	416133901	Zigzag feed spring
14	N/A	Dial tension gear A
15	N/A	Dial tension sensor
16	416412201	Photo sensor complete
17	N/A	BH lever plate
18	N/A	Presser bar adjusting plate
19	N/A	Presser bar spring holder plate
20	416116001	E-Ring□E-3□
21	416120601	Set screw□M3*5A□
22	416412301	BH photo sensor complete
23	N/A	Presser bar plate
24	N/A	BH movement crank
25	416412401	Micro switch seat
26	416412501	BH micro switch complete
27	416412601	Set screw□M2*10□
28	N/A	LED holder
29	N/A	Washer (3.2*8*0.8)
30	416412701	Set screw□M2.5*6□
31	N/A	Cord clip
32	416121201	Set screw□M4*6B□
33	416412901	BH lever crank
34	416413001	BH lever crank spring
35	416413101	BH spring plate
36	270 004230056	Set screw□M3*5B□
37	416413201	BH lever
38	270 003041605	Spring pin (ø1.6×5*0.3)
39	416430801	BH lever button
40	416413401	LED light complete front section
41	N/A	LED cover (1)
42	416413501	Set screw□M3*7□
43	N/A	Bobbin winder PCB
44	416413601	Dial tension supporter plate cover
45	416121501	Set screw (M4×8A)
46	416302901	Nut (M3) t=2.3
47	416413701	Thread guide spring bushing
48	416413801	Thread guide spring
49	N/A	Set screw
50	416413901	Thread guide
51	416414001	Rubber
52	416414101	Needle plate assembly (PFAFF)
53	416122901	Set screw (M4*6)
54	N/A	Bobbin winder PCB Lead cable
55	N/A	Casing
56	N/A	Insulation spacer
57	416414201	Upper Thread crank
58	416414301	Upper Thread crank spring
59	416116101	E-Ring (E-4)
60	N/A	E-Ring (E-2)
61	N/A	E-Ring (E-3)
62	N/A	Washer (WW4-ACP)
63	416414401	Noise elimination cushion
64	270 4230036	Set screw□M3*6B□
65	N/A	Spacer A
66	416414501	Bobbin winder pcb complete
67	416513701	Dial tension knob complete

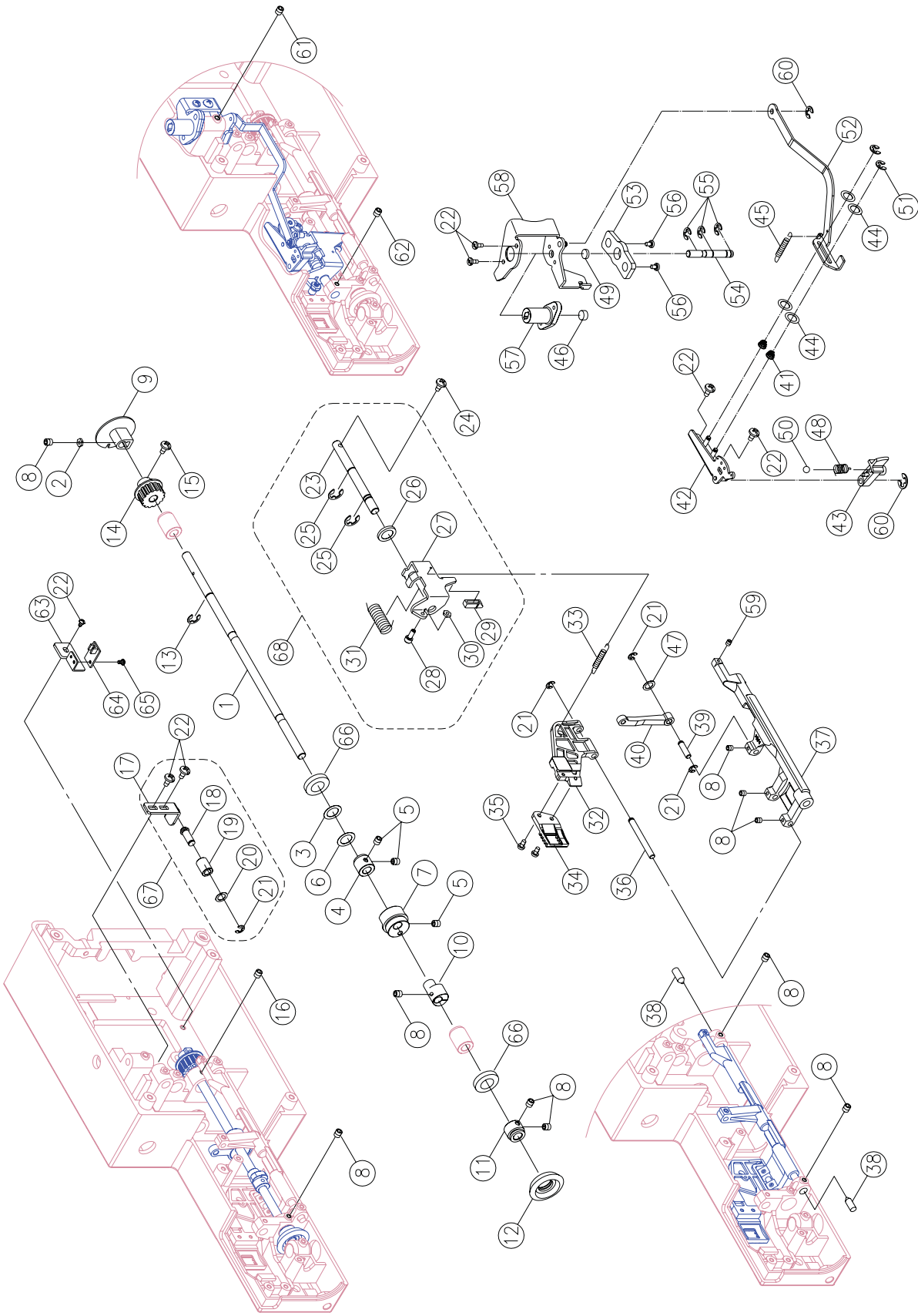

No.	Part No.	Description
1	N/A	Lower shaft
2	270 004840022	Nut (M4 t=3)
3	416186501	Washer (8.2*12*0.25)
4	N/A	Lower shaft collar
5	270 004240503	Set screw (M4*4 C)
6	270 004400410	Washer (8.2*12*0.5)
7	N/A	Feed rock cam
8	416121001	Set screw (M4*5 C)
9	416414701	Lower thread cutter cover
10	N/A	Feed lifting rock cam
11	N/A	Lower shaft gear spacer
12	416414801	Lower shaft gear
13	270 003010063	E-Ring (E-6)
14	N/A	Lower shaft belt pulley
15	N/A	Set screw (M3*14.5)
16	416418301	Set screw (M4*3C)
17	N/A	Belt adjusting plate
18	N/A	Belt adjusting plate shaft
19	N/A	Belt adjusting plate pulley
20	416125901	Washer (6.2*9.6*0.5)
21	416116101	E-Ring □ E-4 □
22	416121501	Set screw (M4*8A)
23	N/A	Feed lifting rock shaft
24	416123101	Set screw (M4×12 A)
25	270 003010073	E-Ring (E-7)
26	N/A	Oil seal
27	N/A	Feed dog crank
28	N/A	Set screw (M4×10)
29	N/A	Silencer cover
30	416126801	Nut (ALN-4)
31	N/A	Spring
32	N/A	Feed rock frame
33	416414901	Feed dog spring
34	416415001	Feed dog
35	416415101	Set screw (M3.5*6A)
36	N/A	Feed rock frame shaft
37	N/A	Feed rock shaft
38	N/A	Feed crank shaft
39	N/A	Feed rock shaft
40	N/A	Feed rock rod crank
41	N/A	Pulse motor spring
42	N/A	Feed dog lifter crank frame
43	416415201	Feed dog lifter crank
44	N/A	Washer(4.2*10*0.5)
45	416415301	Feed dog lifter bat rod spring
46	N/A	Mighty magnet
47	N/A	Washer (5.5*12*0.25)
48	416415401	Feed dog lifter bat rod crank spring
49	N/A	Spacer
50	416415501	Steel ball
51	416116001	E-Ring □ E-3 □
52	N/A	Feed dog lifter bat rod
53	N/A	Supporter adjusting plate
54	N/A	Knee presser bar lifter bat supporter shaft
55	416116301	E-Ring □ E-5 □
56	416121201	Set screw (M4*6B)
57	N/A	Knee presser bar lifter bat
58	N/A	Knee presser bar lifter bat supporter
59	270 004230203	Set screw(M3*4 C)
60	270 003010046	E-Ring
61	270 004250203	Set screw(M5*5 C)
62	N/A	Set screw(M4*5 C)
63	N/A	Lower thread cutter fixed plate
64	416415601	Photo sensor (Lower thread cutter)
65	416120601	Set screw(M3*5A)
66	416404601	Felt seal (□12.7 *□18.7 * t 3.5)
67	416415701	Belt adjusting plate complete
68	416473101	Feed lifting rock shaft complete

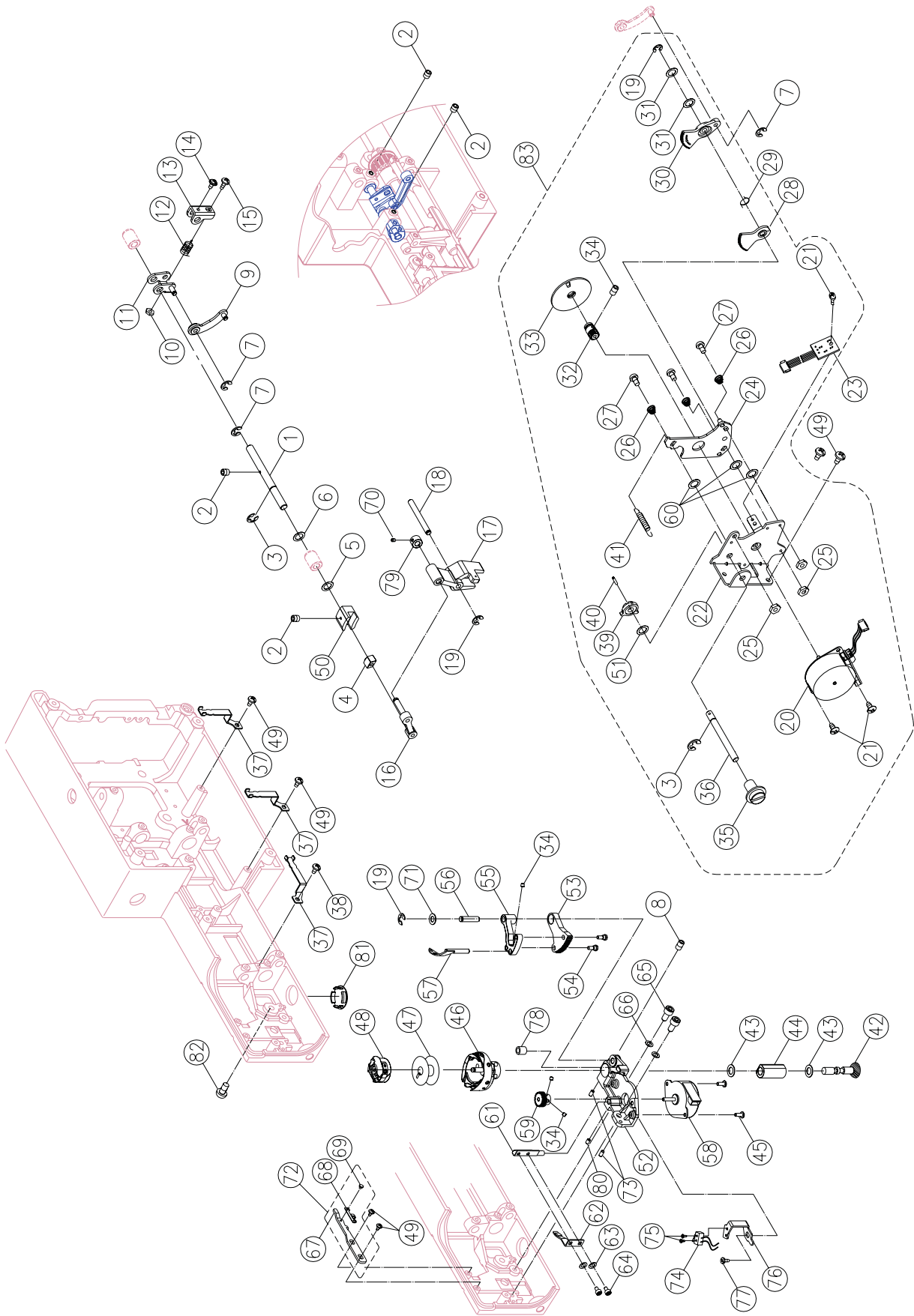

No.	Part No.	Description
1	N/A	Feed regulating crank shaft
2	416121001	Set screw (M4×5 C)
3	416116301	E-Ring□E-5□
4	416415801	Feed regulating block
5	416125601	Washer (6.7*11.8*0.5)
6	N/A	Washer (6.7*12*1)
7	416116001	E-Ring□E-3□
8	270 004250203	Set screw (M5×5C)
9	416415901	Feed rock rod
10	416126801	Nut (ALN-4)
11	416416001	Feed regulating crank (A)
12	270 D3A0293003	Feed regulating crank spring
13	270 D3A0263003	Feed regulating crank (1)
14	N/A	Set screw (M3×0.5) L12
15	270 004241202	Set screw (M4×0.7) L18
16	416416001	Feed rock rod
17	N/A	Feed rock crank
18	N/A	Feed rock crank shaft
19	416116101	E-Ring□E-4□
20	N/A	Pulse motor complete
21	416120601	Set screw (M3×5)
22	N/A	Pulse motor support plate
23	416416101	Feed photo sensor complete
24	N/A	Pulse motor regulating plate
25	416302901	Nut (M3) t=2.3
26	N/A	Pulse motor spring
27	N/A	Location set screw
28	N/A	Feed crank (A)
29	416133901	Zigzag crank spring
30	N/A	Feed crank (B)
31	416186201	Washer (5.2*10*0.2)
32	N/A	Pulse motor gear
33	N/A	Pulse motor gear spacer
34	416120001	Set screw (M3×3C)
35	416416201	Fine tuning dial
36	N/A	Trimming shaft
37	N/A	Electric wire plate A
38	416121201	Set screw (M4×6B)
39	N/A	Feed rock cam
40	N/A	Pin (2*12)
41	N/A	Feed rock spring
42	416416301	Shuttle drive shaft gear
43	416416401	Endure attrition washer (7.6*12.3*0.5)
44	416416501	Shuttle drive shaft bushing
45	416119201	Set screw (M3×6 A)
46	416430901	Rotary hook complete
47	416431001	Bobbin X 3
48	416501201	Bobbin case
49	416121501	Set screw (M4×8 A)
50	416416901	Feed regulating
51	270 004900063	Arc washers(□6.2*□12*2.0*0.15)
52	N/A	Lower thread cutter bracket
53	N/A	Thread cutter feed lifting rock crank
54	N/A	Joint pin
55	N/A	Lower thread cutter crank
56	N/A	Thread cutter crank shaft
57	416417001	Movable shaft
58	416431101	Pulse motor (Mitsumi)
59	416417201	Thread cutter gear
60	416124901	Washer (6.5*11*0.4)
61	416417301	Fixed bracket
62	416417401	Lower thread blade with felt
63	416417501	Washer (□3.1*□5.9*0.7)
64	416417601	Set screws (M3×5)
65	416417701	Set screw (M5×10)
66	416417801	Washer (□6.8*10.7*1.5)
67	N/A	Lower thread cutter bracket B
68	N/A	Lower thread cutter plate B
69	N/A	Rivet
70	N/A	Set screw (M2×4)
71	270 004400180	Endure attrition washer (□5.7*□10.5*0.5)
72	416418601	Lower cutter rotary hook holder complete
73	N/A	Fixed position pin
74	416418001	Micro switch complete
75	416119101	Set screw (M2×7.5)
76	416418101	Plate
77	270 004240676	Set screw (M4×5B)
78	416418201	sleeve
79	N/A	collar
80	416418301	Set screw (M4×3C)
81	416418401	Bobbin shaft gear cover
82	270 004250086	Set screw (M5×12)
83	416418501	Pulse motor support plate complete

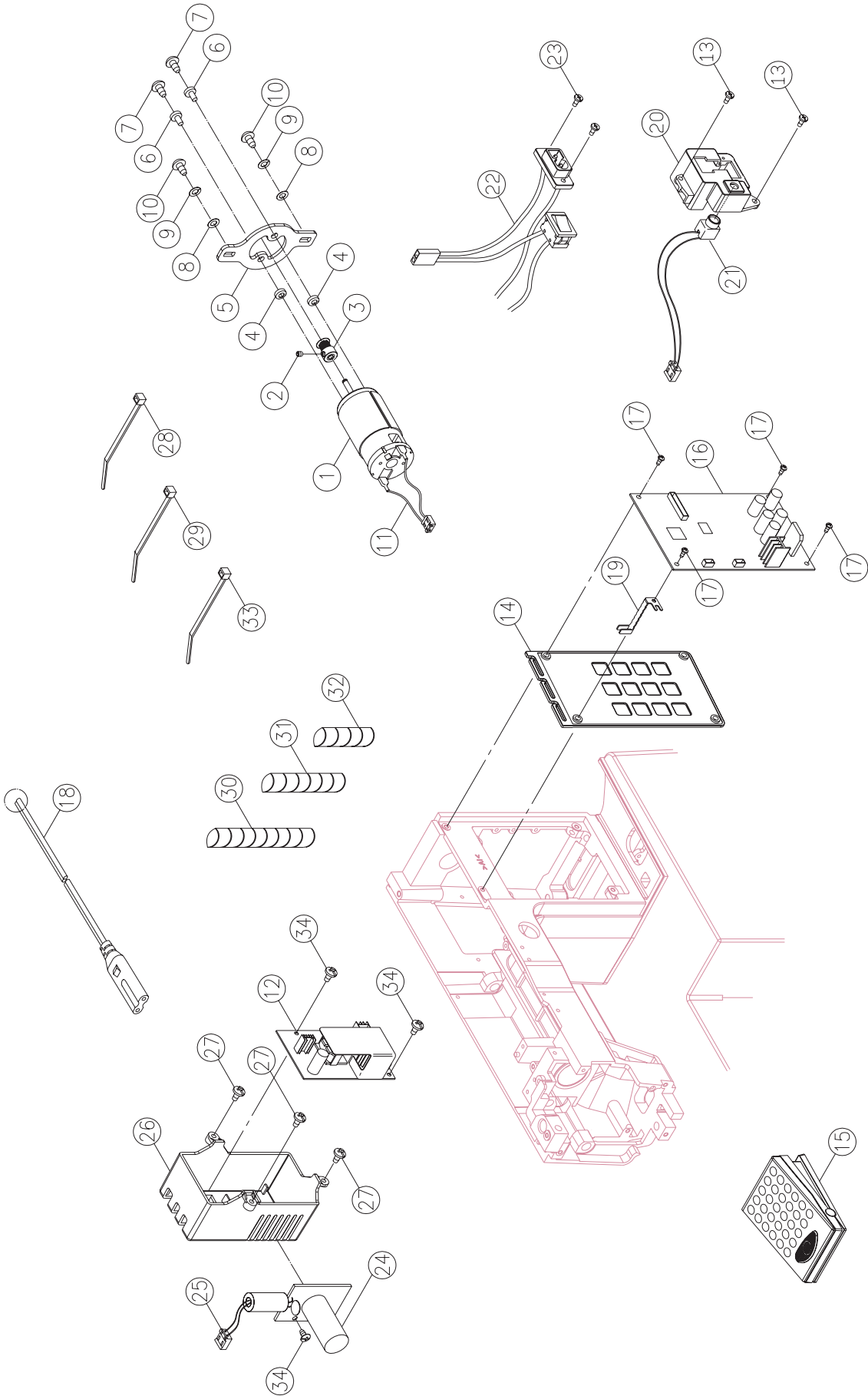

No.	Part No.	Description
1	416418701	DC Motor
2	416120101	Set screw□M3*3□
3	416418801	Motor wheel
4	416418901	Insulation spacer
5	N/A	Motor bracket
6	416419001	Insulation bushing
7	416121101	Set screw□M4*10B□
8	416124301	Washer (5.4*10*0.9)
9	416126201	Washer (5.1*9.2*1.3)
10	270 004250086	Set screw□M5*12□
11	416470501	DC motor wire
12	416419201	HF transformer (for U.S.A)-120V
12	416419301	HF transformer (for EU.) - 240V
13	416121501	Set screw□M4*8 A□
14	416419401	Main circuit board holder
15	416419501	Foot controller
16	416470601	Main circuit board (for PFAFF)
17	416121601	Set screw□M4*12B□
18	416419701	Power cord (for 230V/EU.)
18	416419801	Power cord (for 120V/U.S.A)
18	416419901	Power cord (for 240V/U.K.)
18	416420001	Power cord (for 240V/SAA)
18	N/A	Power cord (for 100V/JAPAN)
19	N/A	Electric wire press board
20	416420101	Receptacle holder
21	416420201	Foot control jack
22	416420401	Receptacle switch assembly
23	270 004230326	Set screw□M3×12B□
24	416420301	Capacitance circuit board (for U.S.A:
24	416470701	Capacitance circuit board (for EU.)
25	416420501	HF transformer wire
26	416420601	HF transformer box
27	416420701	Set screw□M4*15 A□
28	N/A	Cord clip(200*2.5mm)
29	N/A	Cord clip (L=12)
30	416420801	Roll cord clip (L=180)
31	416420901	Roll cord clip (L=100)
32	416421001	Roll cord clip (L=80)
33	N/A	Cord clip (N23)

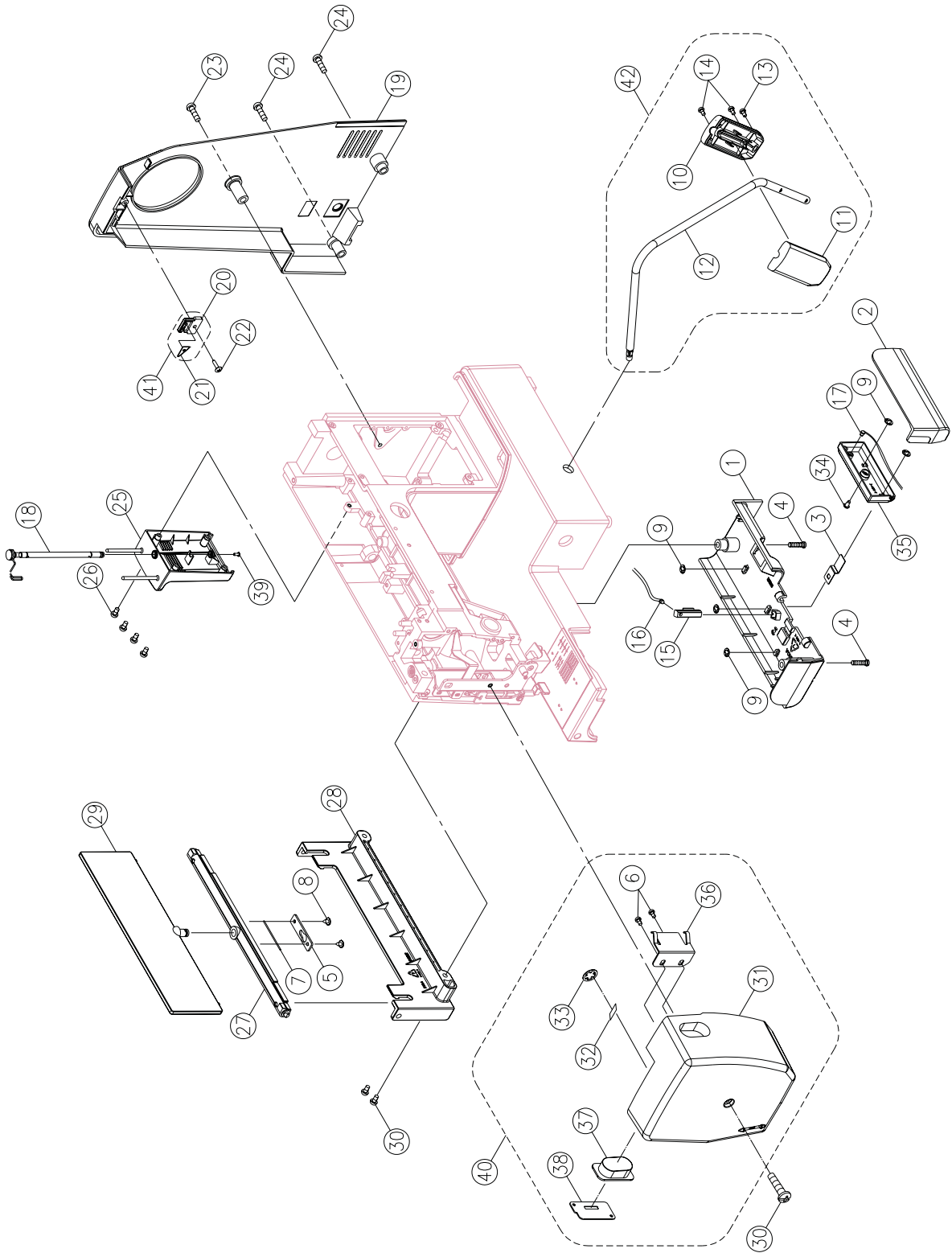

No.	Part No.	Description
1	416476301	Free arm base cover
2	416421201	Hook cover
3	416421301	Hook cover spring
4	270 004240086	Sew screw (M4*20B)
5	416421401	Stitch chart panel bracket
6	270 004230216	Sew screw (M3*8.5)
7	416421501	Fixed position spring
8	416421601	Set screw (M3*6)
9	N/A	CS ring (CSTW-2)
10	N/A	Knee club stem (2)
11	N/A	Knee club stem (1)
12	N/A	Knee lifter
13	416122201	Sew screw (M4*10B)
14	416421701	Sew screw (M4*8A)
15	416421801	Receiver bracket
16	416421901	Thread detect receiver
17	416422001	Thread detect launcher
18	416422101	Thread guide hook fixed holder
19	416422201	Motor drive belt cover
20	N/A	Thread cutter plate
21	416423501	Thread cutter
22	416119501	Sew screw (M3*12B)
23	270 004241106	Sew screw (M4*25)
24	416422401	Sew screw (M4*18)
25	416422501	Spool stand
26	416422601	Sew screw (M4*15A)
27	416422701	Stitch chart panel frame
28	416422801	Stitch chart base holder
29	416422901	Stitch chart panel plate
30	416423001	Sew screw (M4*18A)
31	N/A	Face plate
32	N/A	Thread cutter
33	N/A	CS ring
34	270 004230086	Set screw (M3*6B)
35	416423201	Launcher box
36	N/A	Set plate
37	N/A	Window
38	N/A	Plate
39	416423101	Set screw (M4*8A)
40	416470801	Face plate complete
41	416423501	Thread cutter complete
42	416423401	Knee lifter complete

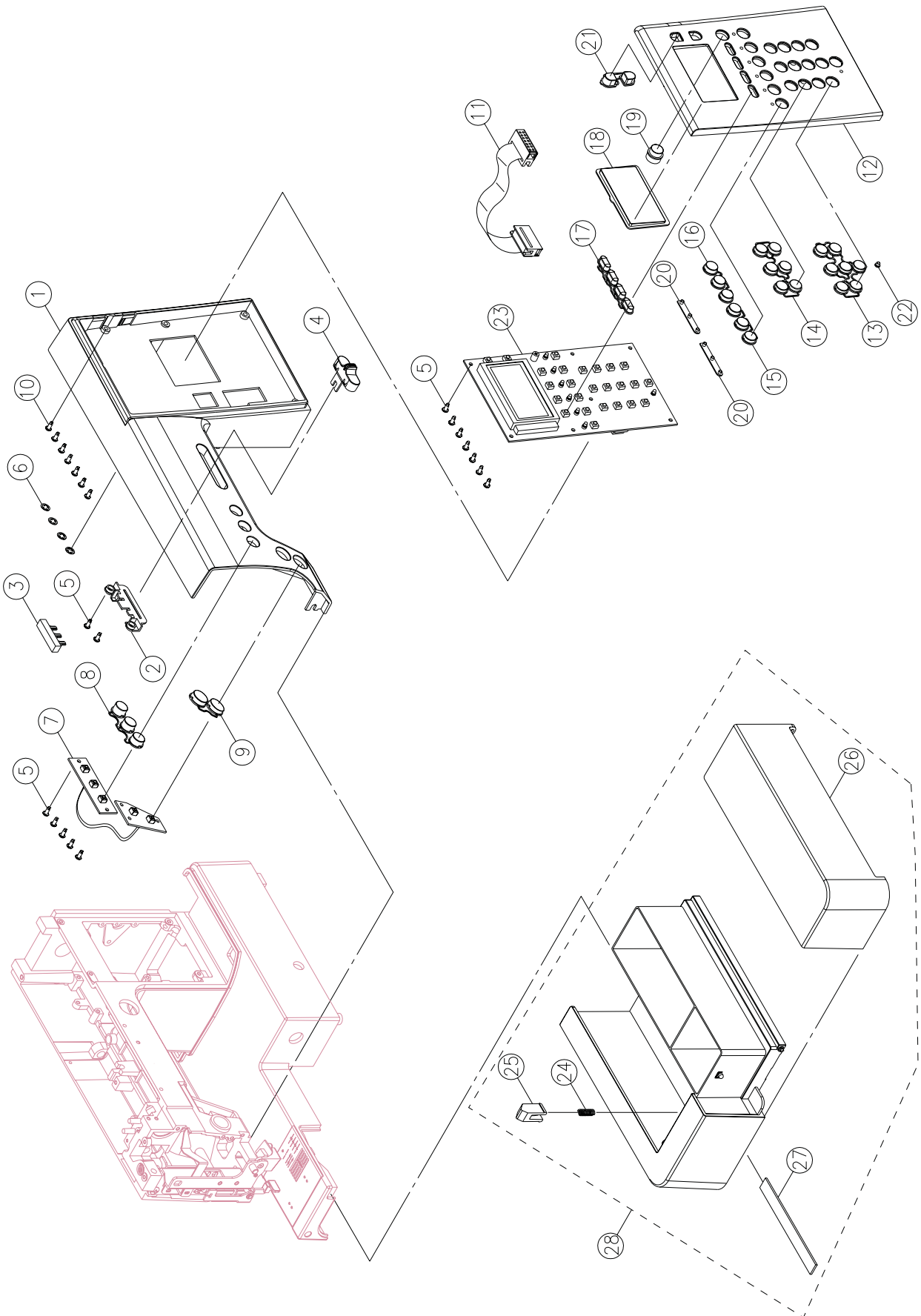

No.	Part No.	Description
1	416470901	Front cover
2	N/A	Slide volume knob connector
3	416423701	Slide volume complete
4	416423801	Slide volume knob
5	270 004230842	Set screw (M3*8)
6	N/A	CS ring(CSTW-4)
7	416423901	Button switch cirwit board
8	N/A	Key pad function buttons
9	N/A	Start stop button
10	270 004230326	Set screw (M3*12 B)
11	416471001	Main lead cable (Flat)
12	416471101	Front panel
13	N/A	Key pad number buttons(2)
14	N/A	Key pad number buttons(1)
15	N/A	Key pad function buttons(C)
16	N/A	Key pad function buttons(B)
17	N/A	Key pad function buttons(A)
18	416424201	LCD screen cover
19	N/A	LCD adjusting knob
20	N/A	LED cover
21	N/A	Dial tension adjusting buttons
22	N/A	LED cover (1)
23	416471201	Main PCB unit
24	416424401	Sewing table body guide spring
25	416424501	Sewing table body guide
26	416424601	Sewing table body cover
27	416471301	Sewing table body felt
28	416424801	Sewing table complete

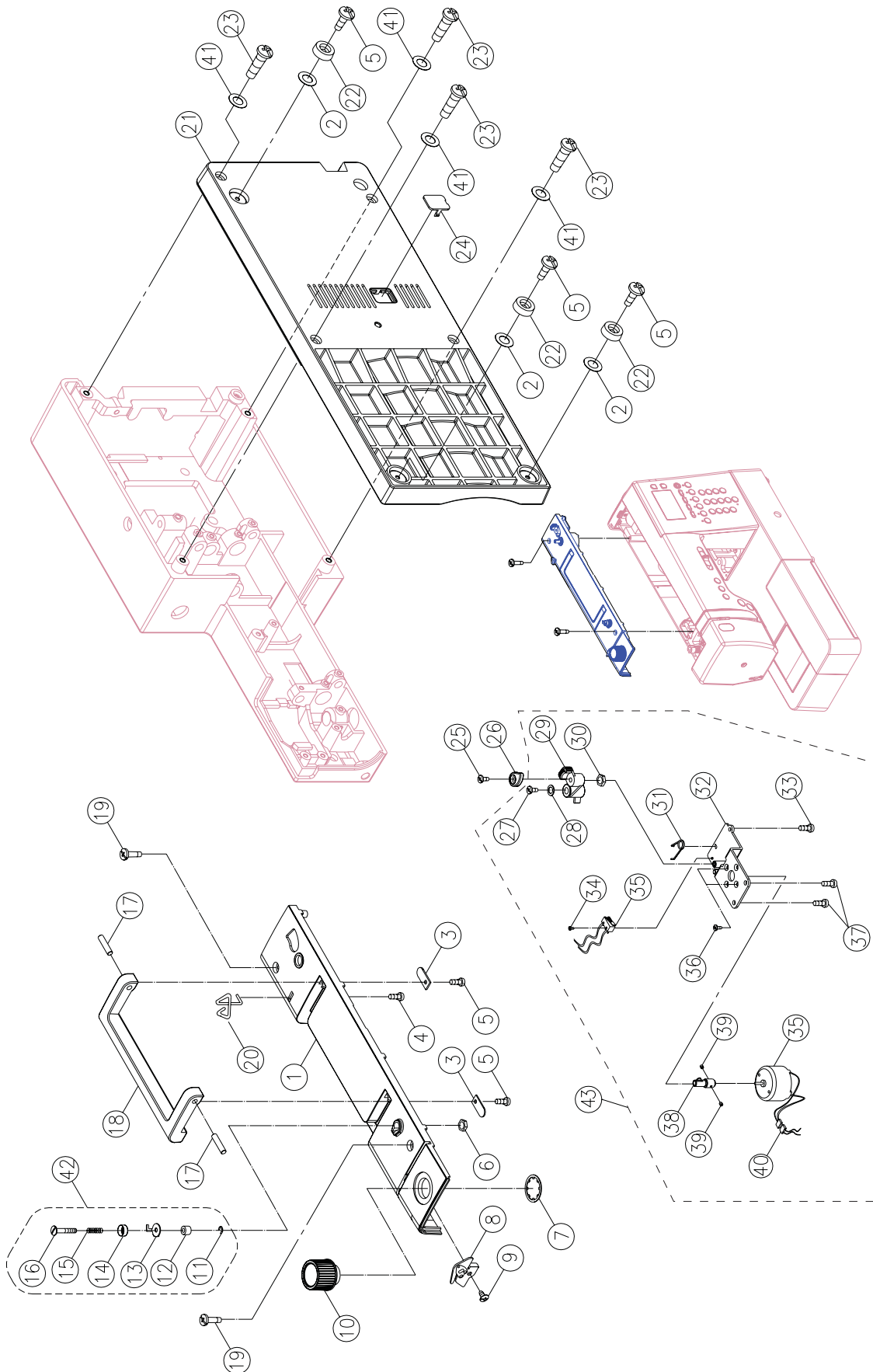

No.	Part No.	Description
1	416471401	Top cover
2	416425001	Washer (4.2*14*1)
3	270 H13093003	Set washer
4	270 004240586	Sew screw (M4*8A)
5	416121501	Sew screw (M4*8A)
6	416126801	Nut (ALN-4)
7	416425101	CS ring (CS-18)
8	416471501	Thread guide complete
9	416119201	Sew screw (M3*6A)
10	416425201	Presser foot adjustable knob
11	416116001	E-Ring □E-3 □
12	N/A	Spacer
13	N/A	Bobbin winder thread guide
14	N/A	Bobbin winder spring disc
15	N/A	Bobbin winder thread guide spring
16	N/A	Bobbin winder thread guide adjusting
17	N/A	Handle pin
18	416425301	Handle
19	416425401	Sew screw (M5*20B)
20	416425501	Thread guide
21	416425601	Free arm base
22	270 J31413000	Machine base rubber feet
23	416425701	Sew screw (M5*18A)
24	416425801	Cover
25	416123101	Set screw (M4×12 A)
26	416425901	Bobbin winder crank (B)
27	N/A	Sew screw (M3*5A)
28	270 004300076	Washer (4.2*9*0.5)
29	416426101	Bobbin winder crank (A)
30	270 004840022	Nut (M4 t=3)
31	416426201	Bobbin winder crank spring
32	N/A	Bobbin winder frame
33	N/A	Sew screw (M3*8B)
34	416119101	Sew screw (M2*7.5)
35	416426301	Bobbin winder including micro switch
36	416426401	Sew screw (M2.5*4)
37	416121201	Sew screw (M4*6B)
38	416471601	Bobbin winder shaft complete (PFAFF)
39	416426701	Set screw (M2*4)
40	N/A	Bobbin winder lead cable 2
41	416126201	Washer (5.1*9.2*1.3)
42	416426601	Bobbin winder thread guide complete
43	416485201	BOBBIN WINDER COMPLETE



Standard accessories

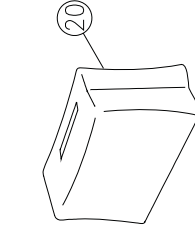
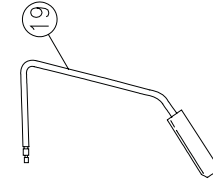
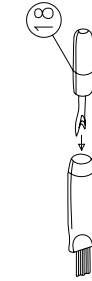
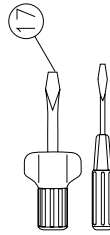
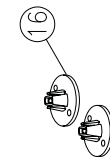
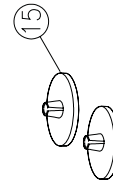
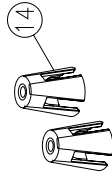
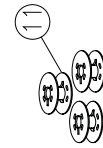
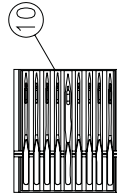
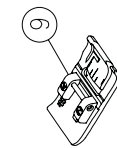
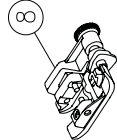
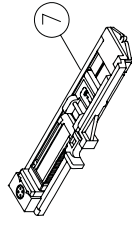
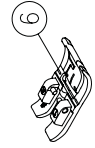
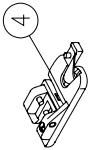
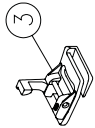
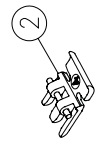
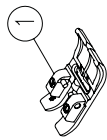

No.	Part No.	Description
1	820773096	Standard presser foot (0A)
2	820248096	Zipper foot (4)
3	820668096	Gathering foot
4	820249096	Rolled hem foot (7)
5	820666096	Three-groove cording foot
6	820774096	Fancy stitches foot (1A)
7	416471701	Buttonhole foot (RP)
8	820256096	Blind hem foot (3)
9	820775096	Fancy stitches foot (2A)
10	620071196	Univ. needle 70/80/90, 5-p
11	416431001	Bobbin (3X)
12	412397701	Net
13	820251096	Edge/quilting guide
14	270 006R1A0039	Cone holder (2X)
15	416426901	Spool cap large(2X)
16	416427001	Spool cap small (2X)
17	416427101	Screwdriver complete (L.S)
18	270 006099008	Brush/seam Ripper
19	416423401	Knee lifter
20	416427201	Soft canvas cover